

• General Description

This silicon carbide Power MOSFET device has been developed using ZMJ's advanced 2nd generation SiC MOSFET technology. The device features a very low $R_{DS(on)}$ over the entire temperature range combined with low capacitances and very high switching operations. It improves application performance in frequency, energy efficiency, system size and weight reduction.

• Features

- High Blocking Voltage
- High Speed Switching With Low Capacitances
- Low $R_{DS(on)}$ to Minimize Conductive Loss
- Low Gate Charge For Fast Switching
- Low Thermal Resistance
- 100% Avalanche Tested
- AEC-Q101 Qualified

• Application

- Motor Drives
- On Board Charger
- DC-DC
- Auxiliary Drives

• Product Summary

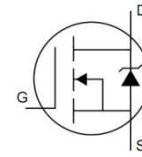

$V_{DS} = 1200V$
 $R_{DS(ON)} = 53m\Omega$
 $I_D = 35A$

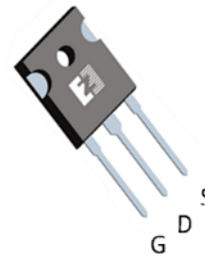

TO-247-3



• Ordering Information:

Part NO.	ZMCA060R120C3
Marking	ZMC060R120
Packing Information	BULK TUBE
Basic Ordering Unit (pcs)	600

• Absolute Maximum Ratings ($T_C=25^\circ C$)

Parameter	Symbol	Conditions	Value	Unit
Drain-Source Voltage	V_{DS}		1200	V
Gate-Source Voltage	V_{GS}	Transient Voltage	-10V/25V	V
	V_{GS}	Static Voltage	-10V/24V	V
Recommended Turn On Gate Voltage	$V_{GS(on)}$		15 to 18V	V
Recommended Turn Off Gate Voltage	$V_{GS(off)}$		-4V to 0V	V
Continuous Drain Current	I_D	$T_C=25^\circ C$	35	A
	I_D	$T_C=75^\circ C$	28	A
	I_D	$T_C=100^\circ C$	24	A

Pulsed Drain Current ^①	I_{DM}	Pulsed; $t_p \leq 10 \mu s$; $T_{mb} = 25^\circ C$;	140	A
Total Power Dissipation	P_D	$T_C = 25^\circ C$	197	W
Total Power Dissipation	P_D	$T_A = 25^\circ C$	3.8	W
Operating Junction Temperature	T_J		-55 to +175	$^\circ C$
Storage Temperature	T_{STG}		-55 to +175	$^\circ C$
Single Pulse Avalanche Energy	E_{AS}	$L=0.5mH, V_{GS}=18V, R_g=25\Omega$	361	mJ
ESD Level (HBM)			Class2	

• Thermal Resistance

Parameter	Symbol	Min.	Typ.	Max.	Unit
Thermal Resistance, Junction - Case	R_{thJC}	-	-	0.76	$^\circ C/W$
Thermal Resistance, Junction-Ambient	$R_{thJA\oplus}$	-	-	40	$^\circ C/W$
Soldering Temperature(total time<10s)	T_{sold}	-	-	260	$^\circ C$

• Electronic Characteristics

Parameter	Symbol	Condition	Min.	Typ.	Max.	Unit
Drain-Source Breakdown Voltage	BV_{DSS}	$V_{GS} = 0V, I_D = 250\mu A$	1200	-	-	V
Gate Threshold Voltage	$V_{GS(TH)}$	$V_{GS} = V_{DS}, I_D = 5mA$	2	2.8	4	V
Drain-Source Leakage Current	I_{DSS}	$V_{GS} = 0V, V_{DS} = 1200V$	-	-	10	μA
Gate- Source Leakage Current	I_{GSS}	$V_{GS} = -10V, V_{DS} = 0V$	-	-	-100	nA
		$V_{GS} = 25V, V_{DS} = 0V$	-	-	100	nA
Static Drain-Source On Resistance	$R_{DS(on)}$	$T_J = 25^\circ C, V_{GS} = 18V, I_D = 20A$	-	53	65	m Ω
		$T_J = 175^\circ C, V_{GS} = 18V, I_D = 20A$	-	110	-	m Ω
		$T_J = 25^\circ C, V_{GS} = 15V, I_D = 20A$	-	63	-	m Ω
Forward Transconductance	g_{fs}	$V_{DS} = 10V, I_{SD} = 20A$	-	8.5	-	S
Diode Forward Voltage	V_{FSD}	$V_{GS} = -4V, I_{SD} = 20A$	-	4.3	5	V

• Dynamic Characteristics

Parameter	Symbol	Condition	Min.	Typ.	Max.	Unit
Input Capacitance	C_{iss}	$f = 100KHz, V_{DS} = 800V$	-	1521	-	pF
Output Capacitance	C_{oss}		-	67	-	
Reverse Transfer Capacitance	C_{rss}		-	5	-	
Output Charge	Q_{oss}	$f = 100KHz, V_{GS} = 0V, V_{DS} = 0V \text{ to } 800V$	-	92	-	nC
Coss Stored Energy	E_{oss}		-	25	-	μJ
Gate Resistance	R_g	$f = 1MHz$	-	1.7	-	Ω
Total Gate Charge	Q_g	$V_{DD} = 800V, I_D = 20A, V_{GS} = -4V/18V$	-	68	-	nC
Gate - Source Charge	Q_{gs}		-	19	-	
Gate - Drain Charge	Q_{gd}		-	28	-	

Turn-ON Delay Time	$t_{D(on)}$	$V_{GS}=-4V/18V, V_{DS}=800V,$ $R_G=10\Omega, I_D=20A,$ $L=505\mu H$	-	13	-	ns
Turn-ON Rise Time	t_r		-	4.2	-	ns
Turn-Off Delay Time	$t_{D(off)}$		-	34	-	ns
Turn-Off Fall Time	t_f		-	15	-	ns
Turn-On Energy	E_{on}		-	580	-	μJ
Turn-Off Energy	E_{off}		-	156	-	μJ
Reverse Recovery Time	t_{rr}	$V_{DD}=800V, di_S/dt =$ $600A/\mu s, I_S=20A$	-	24	-	ns
Reverse Recovery Peak Current	I_{rrm}		-	5.5	-	A
Reverse Recovery Charge	Q_{rr}		-	74	-	nC

● Characteristics Diagrams

Fig.1 Gate-Charge Characteristics

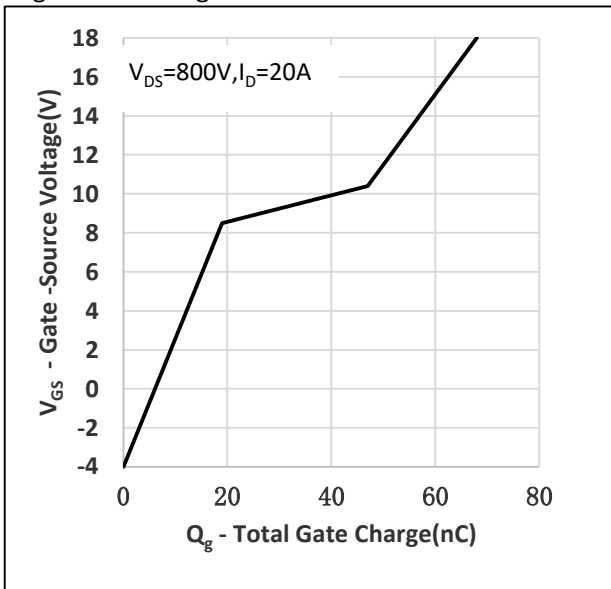

Fig.2 Capacitance Characteristics

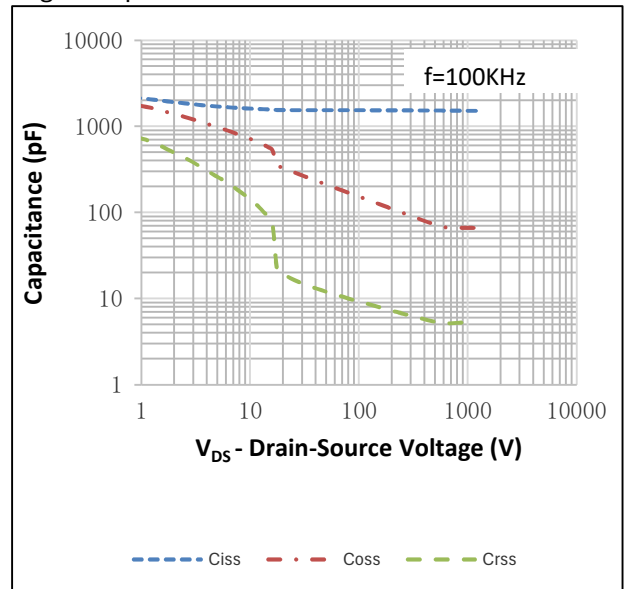

Fig.3 Power Dissipation

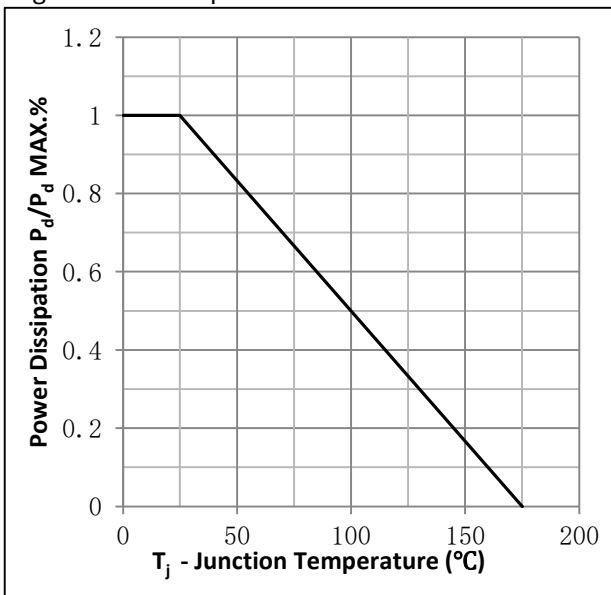

Fig.4 Typical Output Characteristics

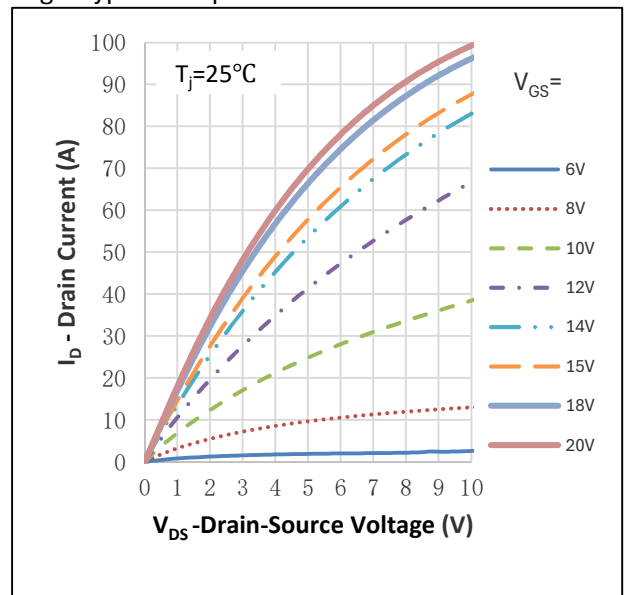

Fig.5 Threshold Voltage vs. Junction Temperature

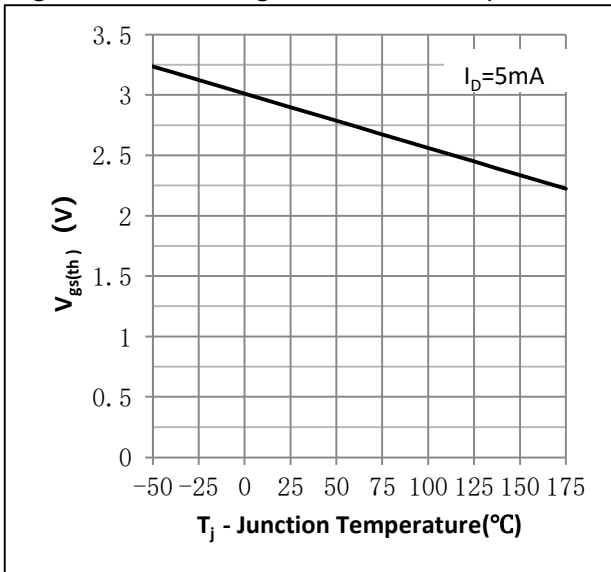

Fig.6 On-Resistance vs. Drain Current

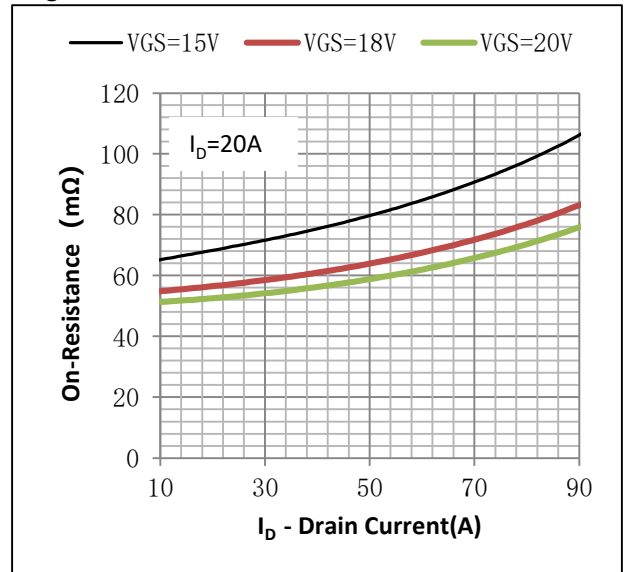

Fig.7 On-Resistance vs. Gate Source Voltage

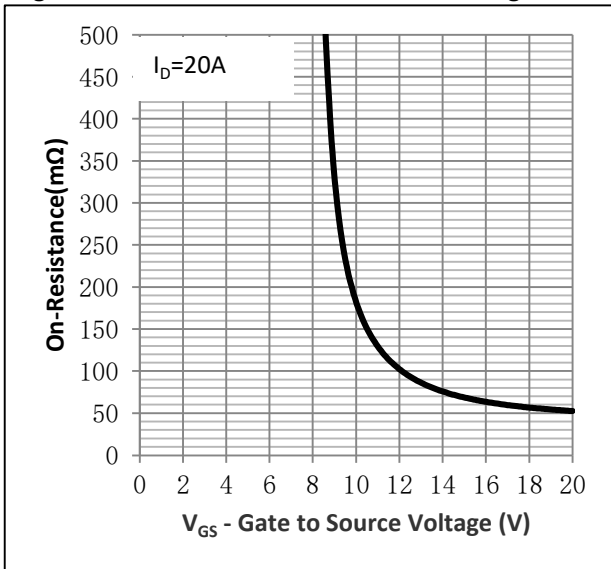

Fig.8 On-Resistance vs. Junction Temperature

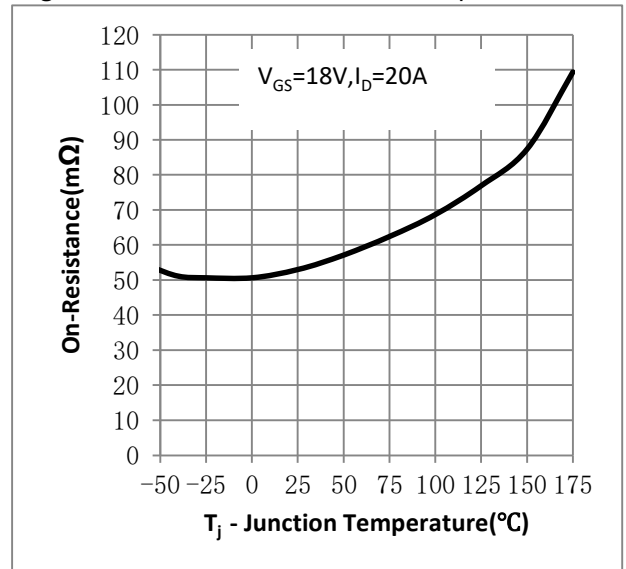

Figure 9. Diode Forward Voltage vs. Current

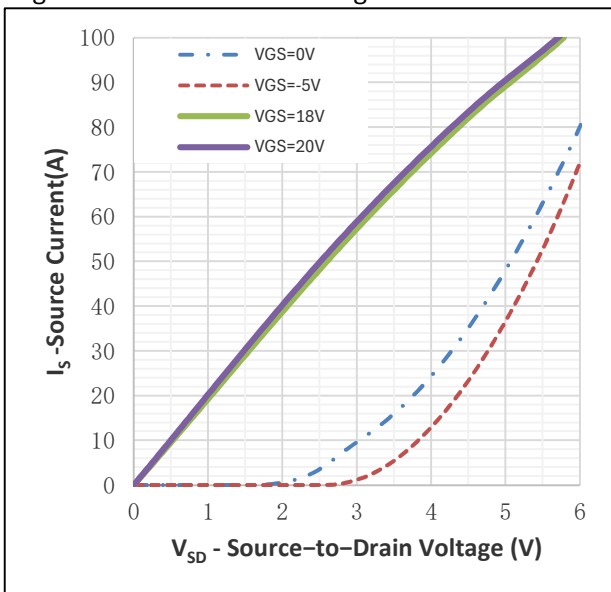

Figure 10. Transfer Characteristics

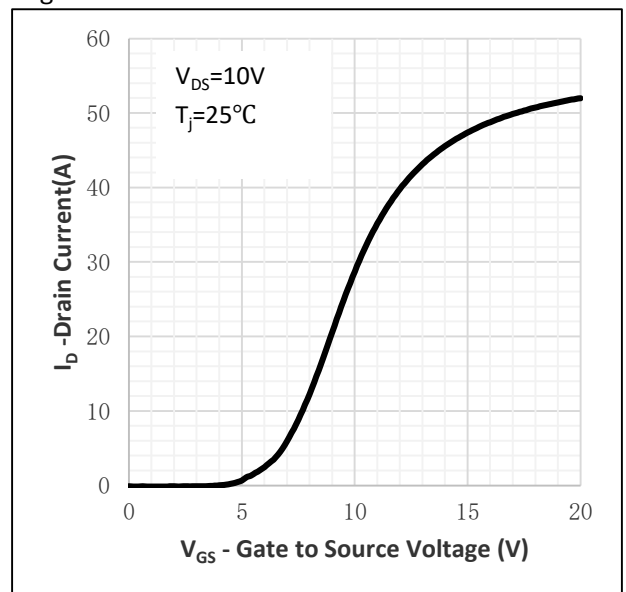

Fig.11 SOA Maximum Safe Operating Area

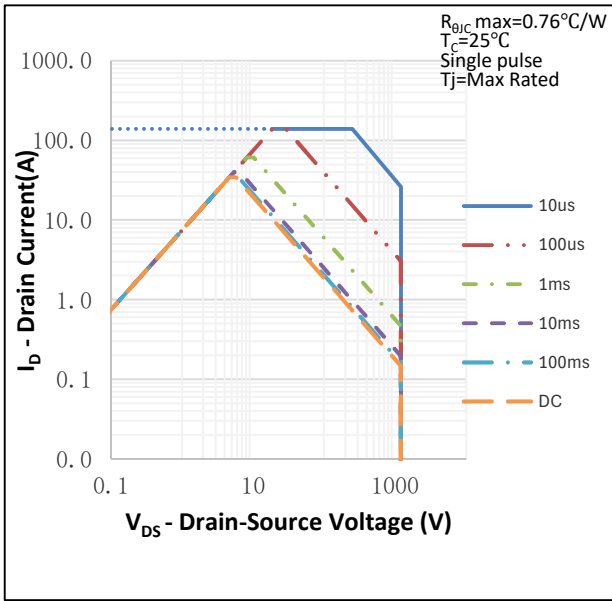

Fig.12 I_D vs. Junction Temperature

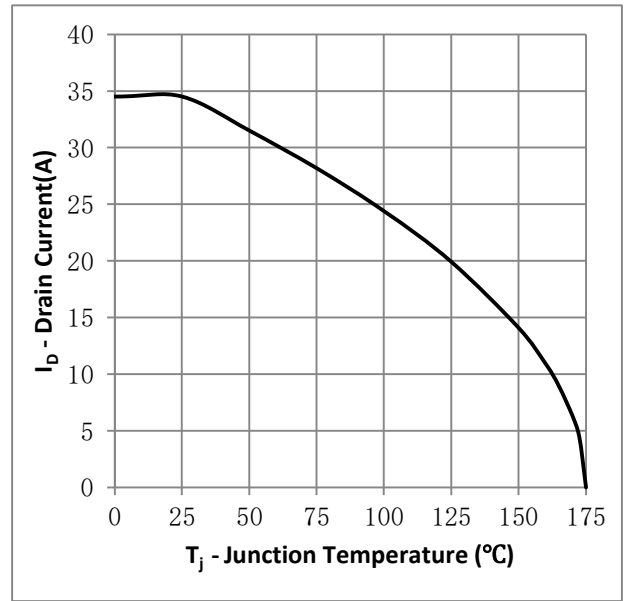

Fig.13 Output Capacitor Stored Energy

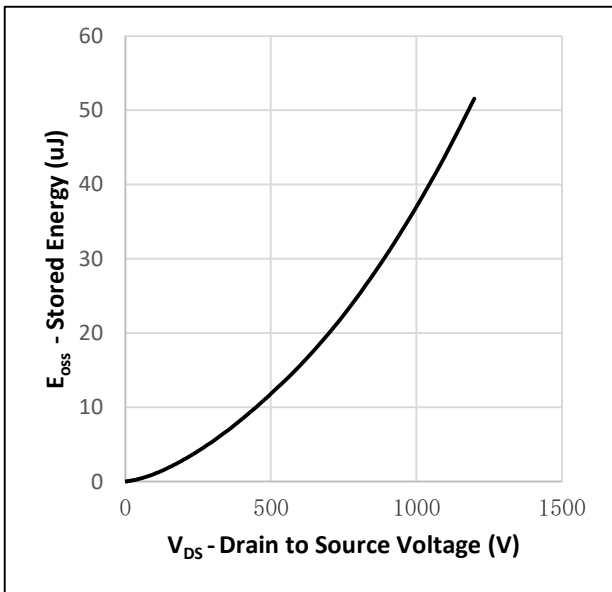
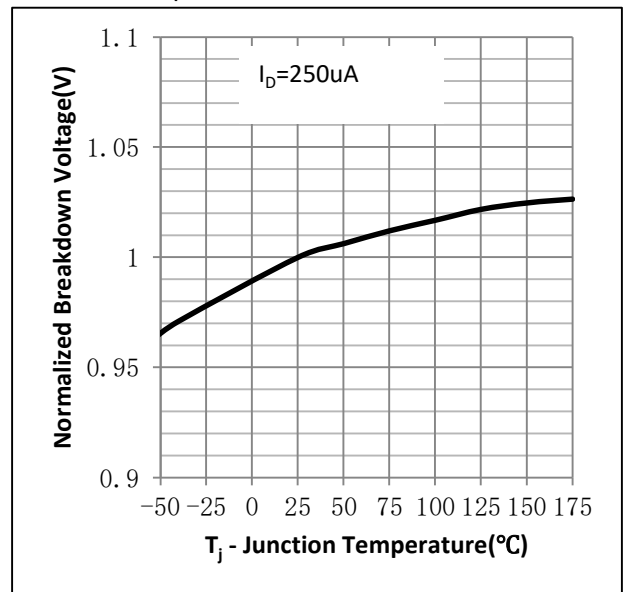
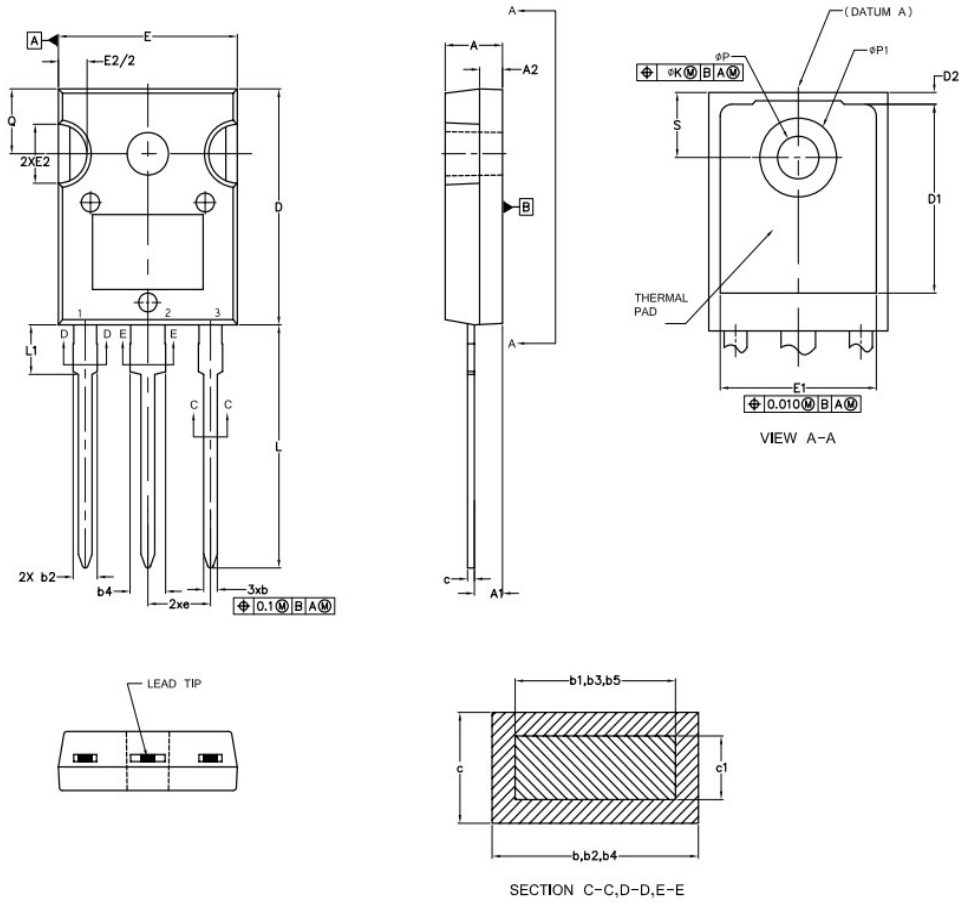

Fig.14 Normalized Breakdown Voltage vs. Junction Temperature



•TO-247-3 Package Outline



DIMENSIONS	DIMENSIONS			
	mm		inch	
	MIN.	MAX.	MIN.	MAX.
A	4.83	5.13	0.190	0.20
A1	2.21	2.59	0.087	0.102
A2	1.50	2.49	0.059	0.098
b	0.99	1.40	0.039	0.055
b1	0.99	1.35	0.039	0.053
b2	1.65	2.39	0.065	0.094
b3	1.65	2.34	0.065	0.092
b4	2.59	3.43	0.102	0.135
b5	2.59	3.38	0.102	0.133
c	0.38	0.89	0.015	0.035
c1	0.38	0.84	0.015	0.033
D	19.71	20.70	0.776	0.815
D1	13.08	—	0.515	—
D2	0.51	1.35	0.020	0.053
E	15.29	15.87	0.602	0.625
E1	13.46	—	0.530	—
E2	4.52	5.49	0.178	0.216
e	5.46BSC		0.215BSC	
L	19.57	21.00	0.780	0.827
L1	3.71	4.29	0.146	0.169
φP	3.56	3.66	0.140	0.144
φP1	—	7.39	—	0.291
Q	5.31	5.69	0.209	0.224
S	5.51BSC		0.217BSC	

Note:

- ① The value of $R\theta JA$ is measured with the device in a still environment with $T_A=25^{\circ}C$
- ② Practically the current will be limited by PCB, thermal design and operating temperature. $V_{GS}=18V$.

Disclaimer

- Reproducing and modifying information of the document is prohibited without permission from ZMJ SEMICONDDUCTORS CO.,LTD.
- ZMJ SEMICONDDUCTORS CO.,LTD. reserves the rights to make changes of the content herein the document anytime without notification. Please refer to our website for the latest document.
- ZMJ SEMICONDDUCTORS CO.,LTD. disclaims any and all liability arising out of the application or use of any product including damages incidentally and consequentially occurred.
- ZMJ SEMICONDDUCTORS CO.,LTD. does not assume any and all implied warranties, including warranties of fitness for particular purpose, non-infringement and merchantability.
- Applications shown on the herein document are examples of standard use and operation. Customers are responsible in comprehending the suitable use in particular applications. ZMJ SEMICONDDUCTORS CO.,LTD. makes no representation or warranty that such applications will be suitable for the specified use without further testing or modification.
- The products shown herein are not designed and authorized for equipments relating to human life and for any applications concerning life-saving or life-sustaining, such as medical instruments, aerospace machinery et cetera. Customers using or selling these products for use in such applications do so at their own risk and agree to fully indemnify ZMJ SEMICONDDUCTORS CO.,LTD. for any damages resulting from such improper use or sale.
- Since ZMJ uses lot number as the tracking base, please provide the lot number for tracking when complaining.

Revision History:

Version	Date	Change
A	2024/11/26	New